



PIPETMAN® SPECIFICATIONS

PARTS CHECKLIST

PIPETMAN® single channel box includes:

- PIPETMAN
- Quick Guide
- Safety bag
- Certificate of Conformity (including barcode sticker)
- Dual-position adapter (P2 and P10 only)
- Leaflet for adapter D10/DL10 (P2 and P10 only)

PIPETMAN® multichannel box includes:

- PIPETMAN
- Quick Guide
- Safety bag
- Certificate of Conformity (including barcode sticker)
- Ejector spacer for D10 tips (Px10 models only)

PIPETMAN® Kits

PIPETMAN single channel models are also available in kits, offering the essential pipetting tools to start an experiment right away.



PIPETMAN® Kits				
Model	Part Number	PIPETMAN® Models	PIPETMAN® DIAMOND Tips	Accessories
PIPETMAN® Starter Kit	F167900	P20 P200 P1000	D200 D1000	3 SINGLE pipette holders 3 PIPETMAN Comfort Handles 1 Sheet of 12 Comfort Handle labels
PIPETMAN® Micro-volume Kit	F167800	P2 P10 P100	DL10 D200	3 SINGLE pipette holders 3 PIPETMAN Comfort Handles 1 Sheet of 12 Comfort Handle labels
PIPETMAN® Large-volume Kit	F167920	P5000 P10mL	D5000 D10mL	2 SINGLE pipette holders 2 PIPETMAN Comfort Handles 1 Sheet of 12 Comfort Handle labels 2 bags of 10 filters
PIPETMAN® Four Pipette Kit	F167360	P2 P20 P200 P1000	DL10 D200 D1000	4 SINGLE pipette holders 4 PIPETMAN Comfort Handles 1 Sheet of 12 Comfort Handle labels



SPECIFICATIONS

PIPETMAN® SINGLE CHANNEL														
Model	PIPETMAN® DIAMOND Tips		Part Number	Nominal Volume (µL)	Volume (µL)	Volume (%)	Maximum Permissible Errors							
							Gilson				ISO 8655-2 (Table 1)			
							Systematic Error (µL)	Random Error (µL)	Systematic Error (%)	Random Error (CV)*	Systematic Error (µL)	Random Error (µL)	Systematic Error (%)	Random Error (CV)*
P2	D10 DL10	DF10ST DFL10ST	F144054M	2	0.2	10	± 0.024	≤ 0.012	± 12.0	≤ 6.0	± 0.050	≤ 0.040	± 25	≤ 20
					0.5	25	± 0.025	≤ 0.012	± 5.0	≤ 2.4	± 0.050	≤ 0.040	± 10	≤ 8
					1	50	± 0.025	≤ 0.012	± 2.5	≤ 1.2	± 0.050	≤ 0.040	± 5.0	≤ 4.0
					2	100	± 0.030	≤ 0.014	± 1.5	≤ 0.7	± 0.050	≤ 0.040	± 2.5	≤ 2.0
P10**	D10 DL10	DF10ST DFL10ST	F144055M	10	1	10	± 0.025	≤ 0.012	± 2.5	≤ 1.2	± 0.120	≤ 0.080	± 12	≤ 8.0
					5	50	± 0.075	≤ 0.030	± 1.5	≤ 0.6	± 0.120	≤ 0.080	± 2.4	≤ 1.6
					10	100	± 0.100	≤ 0.040	± 1.0	≤ 0.4	± 0.120	≤ 0.080	± 1.2	≤ 0.8
P20	D200	DF30ST	F144056M	20	2	10	± 0.10	≤ 0.030	± 5.0	≤ 1.5	± 0.20	≤ 0.100	± 10	≤ 5.0
					5	25	± 0.10	≤ 0.040	± 2.0	≤ 0.8	± 0.20	≤ 0.100	± 4.0	≤ 2.0
					10	50	± 0.10	≤ 0.050	± 1.0	≤ 0.5	± 0.20	≤ 0.100	± 2.0	≤ 1.0
					20	100	± 0.20	≤ 0.060	± 1.0	≤ 0.3	± 0.20	≤ 0.100	± 1.0	≤ 0.5
P100	D200	DF100ST	F144057M	100	10	10	± 0.35	≤ 0.10	± 3.5	≤ 1.0	± 0.80	≤ 0.300	± 8.0	≤ 3.0
					50	50	± 0.40	≤ 0.12	± 0.8	≤ 0.24	± 0.80	≤ 0.300	± 1.6	≤ 0.60
					100	100	± 0.80	≤ 0.15	± 0.8	≤ 0.15	± 0.80	≤ 0.300	± 0.80	≤ 0.30
P200	D200 D300	DF200ST DF300ST	F144059M	200	20	10	± 0.50	≤ 0.20	± 2.5	≤ 1.0	± 1.60	≤ 0.600	± 8.0	≤ 3.0
					100	50	± 0.80	≤ 0.25	± 0.8	≤ 0.25	± 1.60	≤ 0.600	± 1.6	≤ 0.60
					200	100	± 1.60	≤ 0.30	± 0.8	≤ 0.15	± 1.60	≤ 0.600	± 0.80	≤ 0.30
P1000	D1000 D1200	DF1000ST DF1200ST	F144059M	1000	100	10	± 3.0	≤ 0.6	± 3.0	≤ 0.6	± 8.0	≤ 3.0	± 8.0	≤ 3.0
					500	50	± 4.0	≤ 1.0	± 0.8	≤ 0.2	± 8.0	≤ 3.0	± 1.6	≤ 0.60
					1000	100	± 8.0	≤ 1.5	± 0.8	≤ 0.15	± 8.0	≤ 3.0	± 0.80	≤ 0.30
P5000***	D5000		F144066	5000	500	10	± 12	≤ 3	± 2.4	≤ 0.6	± 40.0	≤ 15.0	± 8.0	≤ 3.0
					2500	50	± 15	≤ 5	± 0.6	≤ 0.2	± 40.0	≤ 15.0	± 1.6	≤ 0.60
					5000	100	± 30	≤ 8	± 0.6	≤ 0.16	± 40.0	≤ 15.0	± 0.80	≤ 0.30
P10mL***	D10mL		F144067	10000	1000	10	± 30	≤ 6	± 3.0	≤ 0.6	± 60.0	≤ 30.0	± 6.0	≤ 3.0
					5000	50	± 40	≤ 10	± 0.8	≤ 0.2	± 60.0	≤ 30.0	± 1.2	≤ 0.60
					10000	100	± 60	≤ 16	± 0.6	≤ 0.16	± 60.0	≤ 30.0	± 0.60	≤ 0.30
PIPETMAN® MULTICHANNEL														
Model	PIPETMAN® DIAMOND Tips		Part Number	Nominal Volume (µL)	Volume (µL)	Volume (%)	Maximum Permissible Errors							
							Gilson				ISO 8655-2 (Table 2)			
							Systematic Error (µL)	Random Error (µL)	Systematic Error (%)	Random Error (CV)*	Systematic Error (µL)	Random Error (µL)	Systematic Error (%)	Random Error (CV)*
P8x10	D10 DL10	DF10ST DFL10ST	F144068	10	1	10	± 0.08	≤ 0.05	± 8.0	≤ 5.0	± 0.24	≤ 0.16	± 24	≤ 16
					5	50	± 0.20	≤ 0.10	± 4.0	≤ 2.0	± 0.24	≤ 0.16	± 4.8	≤ 3.2
P12x10			F144069		10	100	± 0.20	≤ 0.10	± 2.0	≤ 1.0	± 0.24	≤ 0.16	± 2.4	≤ 1.6
P8x20	DL10 D200	DFL10ST DF30ST	F144070	20	2	10	± 0.10	≤ 0.08	± 5.0	≤ 4.0	± 0.40	≤ 0.20	± 20	≤ 10
					10	50	± 0.20	≤ 0.10	± 2.0	≤ 1.0	± 0.40	≤ 0.20	± 4.0	≤ 2.0
P12x20			F144071		20	100	± 0.40	≤ 0.20	± 2.0	≤ 1.0	± 0.40	≤ 0.20	± 2.0	≤ 1.0
P8x200	D200 D300	DF200ST DF300ST	F144072	200	20	10	± 0.50	≤ 0.25	± 2.5	≤ 1.25	± 3.20	≤ 1.20	± 16	≤ 6.0
					100	50	± 1.00	≤ 0.40	± 1.0	≤ 0.40	± 3.20	≤ 1.20	± 3.2	≤ 1.2
P12x200			F144073		200	100	± 2.00	≤ 0.50	± 1.0	≤ 0.25	± 3.20	≤ 1.20	± 1.6	≤ 0.60
P8x300	D200 D300	DF200ST DF300ST	F144074	300	30	10	± 1.00	≤ 0.35	± 3.33	≤ 1.17	± 4.8	≤ 1.8	± 16	≤ 6.0
					150	50	± 1.50	≤ 0.60	± 1.0	≤ 0.4	± 4.8	≤ 1.8	± 3.2	≤ 1.2
P12x300			F144075		300	100	± 3.00	≤ 1.00	± 1.0	≤ 0.33	± 4.8	≤ 1.8	± 1.6	≤ 0.60

*CV means Coefficient of Variation (%)

Gilson maximum permissible errors are guaranteed only when PIPETMAN® pipettes are used with the recommended PIPETMAN® DIAMOND Tips.

**P10 model can be used up to 0.5 µL.

***P5000 and P10mL do not have tip ejectors.



DIMENSIONS AND WEIGHT

NOTE

The values below are given as an indication and may vary slightly from one product to another.

Model	Part Number	PIPETMAN® Models without Packaging		PIPETMAN® Models with Packaging	
		Length (mm)	Weight (kg)	Dimensions (mm) (W x D x H)	Weight (kg)
PIPETMAN® Single Channel					
PIPETMAN P2	F144054M	243	0.096	32 x 11 x 4	0.19
PIPETMAN P10	F144055M	245	0.098	32 x 11 x 4	0.19
PIPETMAN P20	F144056M	258	0.099	32 x 11 x 4	0.19
PIPETMAN P100	F144057M	257	0.098	32 x 11 x 4	0.19
PIPETMAN P200	F144058M	253	0.108	32 x 11 x 4	0.2
PIPETMAN P1000	F144059M	284	0.120	32 x 11 x 4	0.21
PIPETMAN P5000	F144066	277	0.128	32 x 11 x 5	0.24
PIPETMAN P10ML	F144067	276	0.166	32 x 11 x 5	0.31
PIPETMAN® Multichannel					
PIPETMAN P8X10	F144068	275	0.200	33 x 15.5 x 4	0.39
PIPETMAN P12X10	F144069	275	0.250	33 x 15.5 x 4	0.44
PIPETMAN P8X20	F144070	273	0.200	33 x 15.5 x 4	0.37
PIPETMAN 12X20	F144071	273	0.245	33 x 15.5 x 4	0.4
PIPETMAN P8X200	F144072	268	0.210	33 x 15.5 x 4	0.38
PIPETMAN P12X200	F144073	268	0.265	33 x 15.5 x 4	0.415
PIPETMAN P8X300	F144074	260	0.230	33 x 15.5 x 4	0.4
PIPETMAN P12X300	F144075	260	0.275	33 x 15.5 x 4	0.45





DESCRIPTION AND MATERIALS

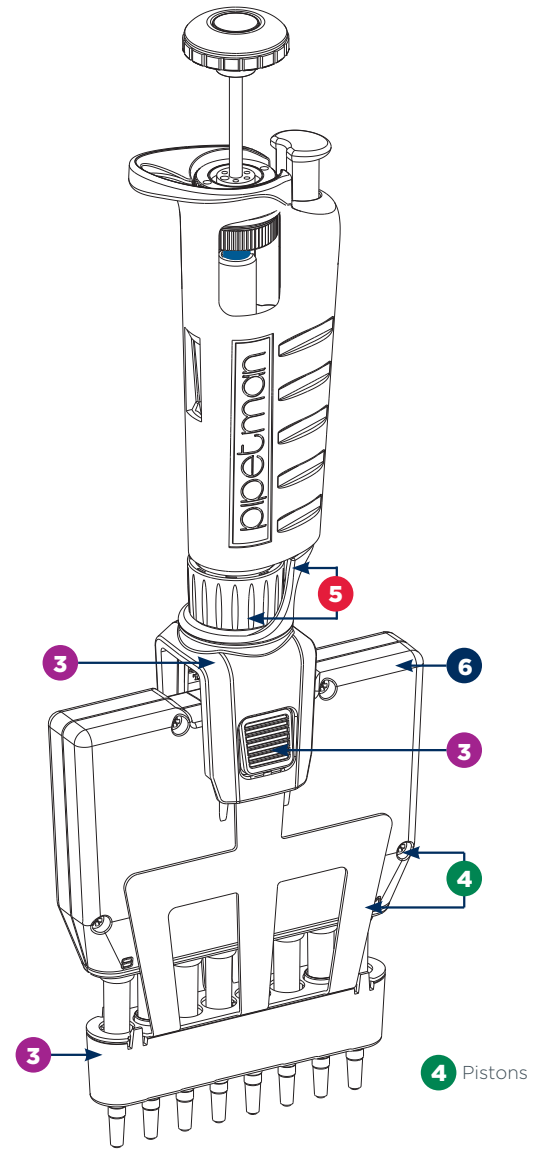
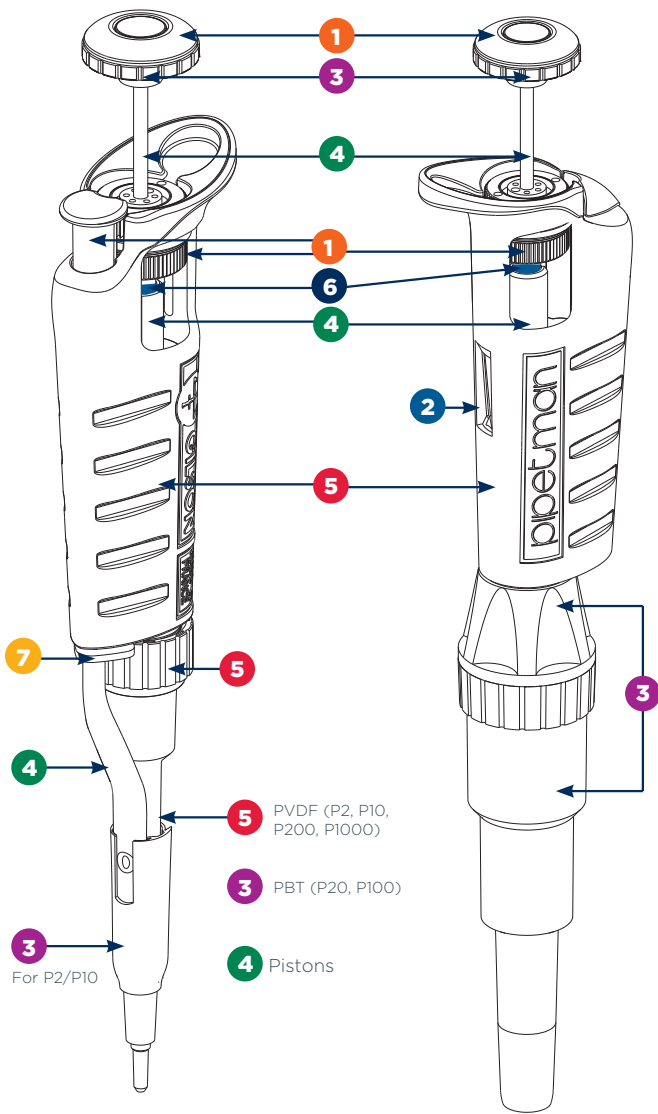

Label	Materials
1	Poly Oxy Methylene (POM)
2	Polycarbonate (PC)
3	Polybutylene Therephtalate (PBT)
4	Stainless Steel (SS)
5	Polyvinylidene Fluoride (PVDF)
6	Polyamide (PA)
7	Polypropylene (PP)



ACCESSORIES

To make pipetting more comfortable and more convenient, Gilson has developed several accessories:

DESCRIPTION	PART NUMBER
Plastic Ejector P2/P10 with Adapter	F107027
Plastic Ejector P20	F107028
Plastic Ejector P100	F107029
Plastic Ejector P200	F107030
Plastic Ejector P1000	F107031



Plastic tip ejector

Pipette stands allow users to store pipettes vertically to avoid the possibility of liquid running back into the pipette.

DESCRIPTION	PART NUMBER
CARROUSEL™ Pipette Stand (7 pipettes)	F161401
TRIO™ Stand (3 pipettes)	F161405
Universal Multichannel Stand*	F161417
SINGLE™ Pipette Holder	F161406

CARROUSEL™



Universal Multichannel Stand



TRIO™



SINGLE™



*Universal multichannel stand is for multichannel models only.

To identify or personalize your pipette, COLORIS™ Identification Clips are available.

DESCRIPTION	PART NUMBER
COLORIS Clips (mixed colors set of 10)	F161301
COLORIS Clips (red, set of 10)	F161302
COLORIS Clips (yellow, set of 10)	F161303
COLORIS Clips (green, set of 10)	F161304
COLORIS Clips (blue, set of 10)	F161305
COLORIS Clips (white, set of 10)	F161306



With The JIMMY™ Microtube Opener, a hands-free microtube opener, you can open both snap-cap and screw-cap microtubes.

DESCRIPTION	PART NUMBER
JIMMY Microtube Opener (set of 3)	F144983





For P5000 and P10mL models, disposable filters maintain the pipette's original accuracy and precision by creating an efficient barrier to aerosols or corrosive vapours such as acids which could damage mechanical parts.

DESCRIPTION	PART NUMBER
Bag of 10 Filters for P5000/P10mL	F161280
Bag of 100 Filters for P5000/P10mL	F161241



PIPETMAN® COMFORT HANDLE models reduce the force needed to grip the pipette for maximum comfort.

DESCRIPTION	PART NUMBER
PIPETMAN® COMFORT HANDLE (pack of 3, blue)	F161486
PIPETMAN® COMFORT HANDLE (pack of 3, white)	F161488
PIPETMAN® COMFORT HANDLE (pack of 50, blue)	F161485
PIPETMAN® COMFORT HANDLE (pack of 50, white)	F161487
PIPETMAN® COMFORT HANDLE (stickers, 120)	F161499





SPARE PARTS

Service Kit 1st level includes:

- 3 piston seals* or seal guides **C**
- 3 O-rings* **D**
- 1 tip holder **E**

Service Kit 2nd level includes:

- 1 push button **A**
- 1 connecting nut **B**
- Stainless steel tip ejector **F2**
- Plastic tip ejector **F1** (also available separately as an accessory)

For P2 and P10 models only:

- 1 dual-position adapter for stainless steel tip ejector **F3**
- 1 extension for plastic tip ejector **F4**

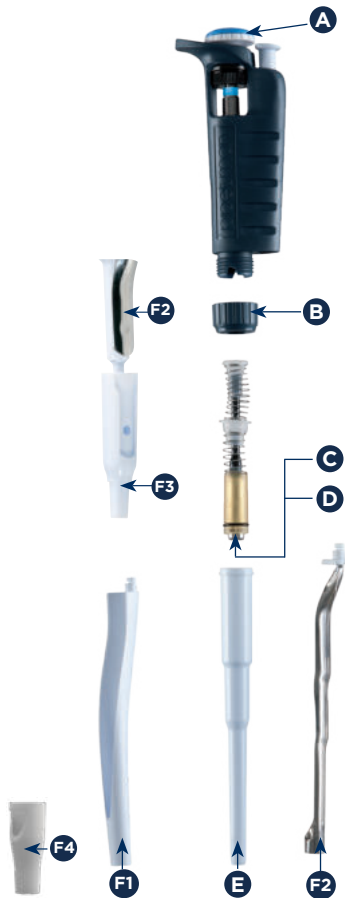

Single Channel Models

P2 (F144054M) AND P10 (F144055M)			
LABEL	DESCRIPTION	P/N FOR P2	P/N FOR P10
C+D+E	Service Kit 1st level	F144501	FA07001
A+B+F1 to F4	Service Kit 2nd level	F1619702	F1619712
C+D	Seal Guide + O-ring (5 sets)	F144861	FA07012
F3	Dual-Position Adapter (x5)	F144879	F144879
F4	Tip ejector extension	F2070903	F2070903

P20 (F144056M) AND P100 (F144057M)			
LABEL	DESCRIPTION	P/N FOR P20	P/N FOR P100
C+D+E	Service Kit 1st level	FA07002	FA07003
A+B+F1+F2	Service Kit 2nd level	F1619722	F1619732
C+D	Seal Guide + O-ring (5 sets)	FA07013	FA07014

P200 (F144058M) AND P1000 (F144059M)			
LABEL	DESCRIPTION	P/N FOR P200	P/N FOR P1000
C+D+E	Service Kit 1st level	FA07004	FA07005
A+B+F1+F2	Service Kit 2nd level	F1619742	F1619782
C+D	Seal Guide + O-ring (5 sets)	FA07015	FA07016

P5000 (F144066) AND P10ML (F144067)			
LABEL	DESCRIPTION	P/N FOR P5000	P/N FOR P10ML
C+D+E	Service Kit 1st level	FA07311	FA07312
C+D	Seal Guide + O-ring (2 sets)	FA07307	FA07308
E	Tip holder	FA07350	F161263

DESCRIPTION	PART NUMBER
Lubricant	5440011070

Multichannel Models

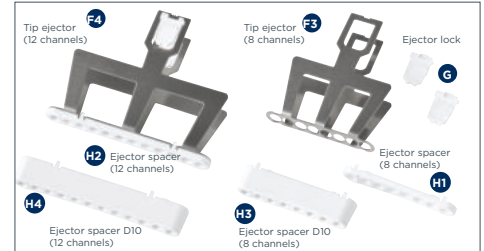

P8X10 (F144068) AND P12X10 (F144069)			
LABEL	DESCRIPTION	P/N FOR P8X10	P/N FOR P12X10
F3-F4	Tip ejector	F507005	F507006
G	Ejector lock	F507008	F507008
H1 - H2	Ejector spacer	F507001	F507003
H3 - H4	Ejector spacer D10	F807114	F807115

P8X20 (F144070) AND P12X20 (F144071)			
LABEL	DESCRIPTION	P/N FOR P8X20	P/N FOR P12X20
F3-F4	Tip ejector	F507005	F507006
G	Ejector lock	F507008	F507008
H1 - H2	Ejector spacer	F507001	F507003

P8X200 (F144072) AND P12X200 (F144073)			
LABEL	DESCRIPTION	P/N FOR P8X200	P/N FOR P12X200
F3-F4	Tip ejector	F507005	F507006
G	Ejector lock	F507008	F507008
H1 - H2	Ejector spacer	F507001	F507003

P8X300 (F144074) AND P12X300 (F144075)			
LABEL	DESCRIPTION	P/N FOR P8X300	P/N FOR P12X300
F3-F4	Tip ejector	F507005	F507006
G	Ejector lock	F507008	F507008
H1-H2	Ejector spacer	F507001	F507003

* For P5000, two piston seals and O-rings are provided the Service Kit 1st level.



REGULATORY COMPLIANCE

PIPETMAN® conforms to the Use of Hazardous Substances Directive **2015/863/EU**

WARRANTY

Gilson warrants this pipette against defects in material under normal use and service for a period of **three years for both single channel and multichannel models** from the date of purchase.

This warranty shall not apply to pipettes which are subject to abnormal use and/or improper or inadequate maintenance (contrary to the recommendations given in the user's guide), including, but not limited to pipettes which have been subjected to physical damage, improper handling, or spillage or exposure to any corrosive environment. This warranty shall also be void in the event pipettes are altered or modified by any party other than Gilson or its designates. Gilson's sole liability under this warranty shall be limited to, at Gilson's sole option, repair, or replacement of any defective components of pipettes or refund of the purchase price paid for such pipettes. **Routine cleaning, control, and recalibration are not covered under the warranty. The replacement of wearing parts such as seals, o-rings, broken pistons assembly, and broken tip holders are not covered under the warranty.**

NOTICE

Yearly routine maintenance is highly recommended to keep your pipette in good condition, ensuring a continued high level of performance.

gilson.com/contactus